

Varenummer: 20990ALD181000EL
Beskrivelse: E+G GN 990 Rundt konstruktionsrør
GN 990-AL-D18-1000-EL

Mål

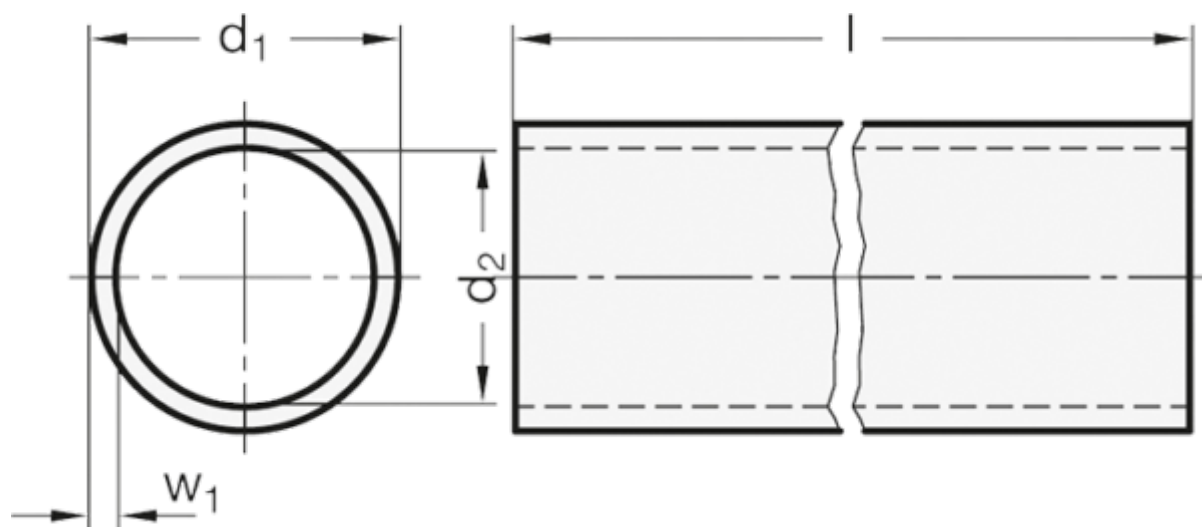

d_1	= D18 +0.05/-0.15
d_2	= 15
$l \pm 0.5$	= 1000
Vægt i (g)	= 208
w_1	= 1.5